

EX6

STANDALONE KEYPAD

Designed to operate indoors or outdoors, EX6 is available in a variety of housing options (plastic/metal) for flush and surface mounting.

The standalone keypad EX6 can be connected to the I/O board RBO408 in order to expand the number of outputs to 10 relays.



FEATURES

- 1000 User Codes
- Code lengths between 1 to 8 digits
- Voltage-free red and green LEDs
- All keys with backlighting
- Tamper protection
- Security: 30 seconds lockout after 8 consecutive invalid PIN Codes or Cards
- Two inputs for Push Buttons
- RS485 bus for I/O boards (RBO408, RU2, RTT & DINRTT)
- 2 relays - with the option to install up to 10 relays by using panel board RBO408
- Option of Plastic keys or Metal to withstand heavy usage
- Aesthetic design suitable for wide variety of decors

SPECIFICATIONS

Electrical Characteristics:

Input Voltage: 12/24V AC/DC

Current consumption: Max 150 mA

Output: 2 relays

- R1: 10A/24 V AC/DC;

- R2: 2A/24 V AC/DC;

10 relays

- with RBO408 I/O board

RS485 interface: Yes, for connecting I/O boards like RBO408, RTT, RU2, DINRTT

Buzzer, backlight control: Yes, via menu settings

Lighting: Backlight ON/OFF or on each keypress for 10 seconds

Visible LED Signal: Two voltage free LEDs

(Red & Green) and Orange LED

Audible Signal: One internal Buzzer

Environmental Characteristics:

Operating Temperature: -25° to +50°

Operating Humidity: 0 to 95% (non-condensing)

Protection Standard: IP65

Mechanical Characteristics:

Housing: ABS or sturdy die-cast aluminum alloy housing for surface mounting & Steel plate for flush mounting

DIMENSIONS

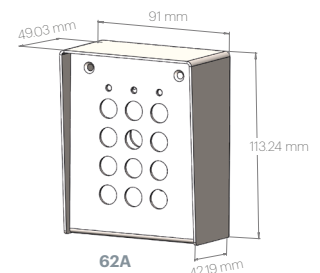
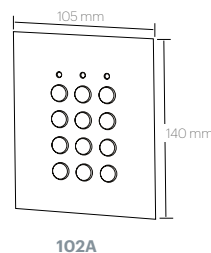
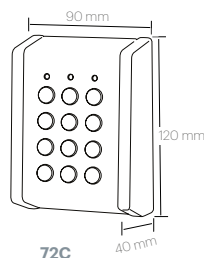
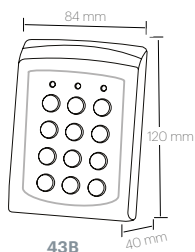

WITH REMOTE RELAY AT SECURED AREA

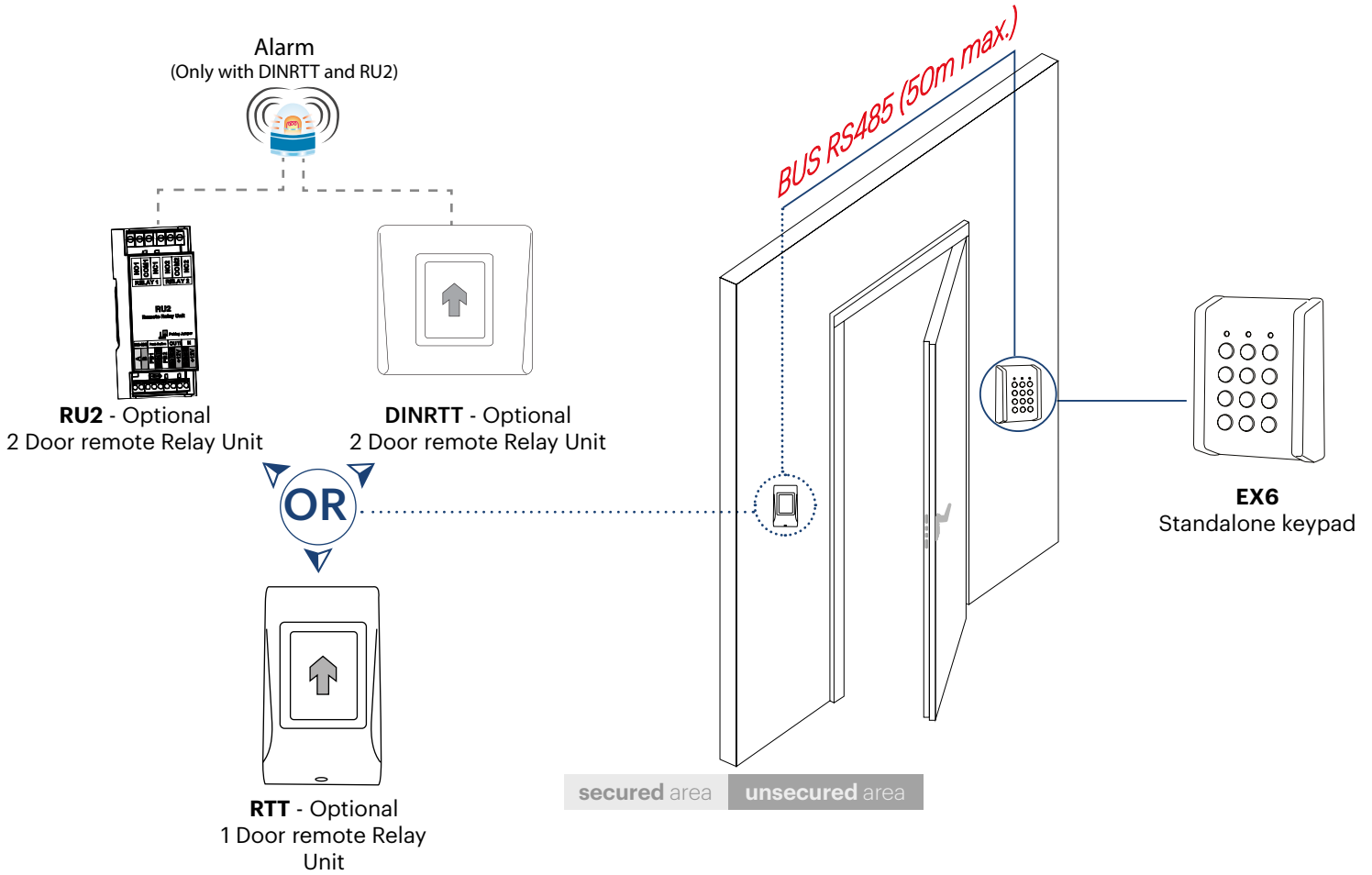

WITH RELAY BOARD RB0408 TO ADD 8 RELAYS TO YOUR 2 RELAYS INSTALLATION

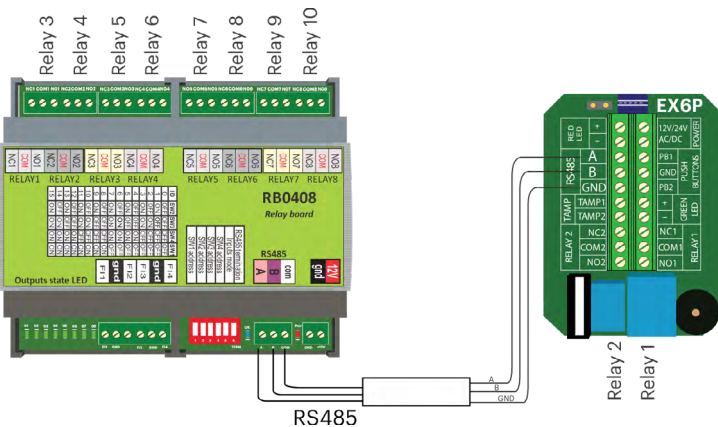

The EX6 connected to the RB0408 is perfect for small standalone installations that require more than 2 relays. The 2 relays of the EX6 + the 8 relays of the RB0408 gives you the opportunity to manage up to 10 relays.

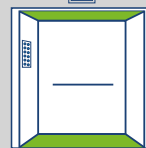

Lift solution:
max 10 floors



Cupboard solution:
max 10 drawers



Clothes shop solution:
max 10 fitting room doors