

MAINTAINED/NON MAINTAINED ILLUMINATION SIGNS WITH GREEN LEDs



TECHNICAL CHARACTERISTICS *(for LED MODULE Specs. see page 4)*

	MLD-28S/g	MLD-34S/g	MLD-44S/g
Mains voltage	220-240V AC/50-60Hz		
Maximum power consumption	3W / 7.5VA		3W / 8VA
Battery (Ni-Cd)	3.6V/1Ah		
Battery protection	Overcharging and deep discharging protection		
Recharging time	24h		
Minimum emergency duration	3h		
Light source intensity (Mains / Emerg)	18lm / 18lm		22lm / 18lm
Degrees of cover protection	IP 40		
Class of cover protection	class II		
Produced in accordance with	EN 60598-1, EN 60598-2-1, EN 55015, EN 61547, EN 61000-3-2, EN 61000-3-3		
Operation temperature range	5 to 40 °C		
Relative humidity	Up to 95%		
External panel's dimensions	280x100mm	340x170mm	440x220mm
External dimensions (LxWxH)	305x25x155mm	350x25x205mm	465x25x275mm
Construction materials	ABS/PC, Plexiglass, PVC		
Typical weight	500gr.	800gr.	1160gr.
Guarantee	3 years (1 year for the battery)		

Thank you for your trust in our product Olympia Electronics - European manufacturer

GENERAL

These new sign illumination luminaires, use a new technology, friendly to the environment, with high illuminated L.E.D.s. L.E.D. technology has very low power consumption. The edge illumination sign is used as a maintained backup lighting with indications symbols. Each package contains arrows stickers which are used to quickly design the required sign which is suitable for each occasion.

Just place the sign on the figure which is designed on the packages and stick the arrow.

Each model combines modern, aesthetics, together with functionality. The exit illumination signs are used in every public area where clear direction and good appearance are important.

NON MAINTAINED OPERATION

By default the illumination sign operates as maintained. The device has a possibility to operate as non maintained. To change the maintained to non maintained operation follow the relative instructions on page 6. All models must be permanently connected to the mains power supply as shown on page 2. The legend is screened on to a clear acrylic sheet which has the marking on the marking panel with the light that comes from the top of the luminaire and diffracts, giving light to the marking panel. The luminaire has an indication (CHARGE) for the charging of the battery and a (TEST) button to TEST the emergency circuit and the LEDs for good operation only when the luminaire is powered by the mains power supply. The unit must be mounted in a clearly visible area and can either be hung on a ceiling or mounted on a wall

depending on the requirements of the installation. The package includes all the required materials for mounting on the wall or on the ceiling. The pages 2,3 and 4 show us the mounting methods.

WARNING !!

1. Read carefully this instruction manual.
2. Before service interrupt the mains power supply.
3. The device must be connected to the mains power supply through a fuse dependent by the total amount of the line's power load.
4. It is suggested to check every month the indication LED for battery charging, and by pushing briefly the TEST button to check the emergency circuit. The sign should light for a few seconds powered by the battery and then, will turn to normal operation. In the opposite condition contact the installer.
5. Every six months, a full duration check should be carried out by disconnecting the mains power supply. Count the autonomous duration of the luminaire and in case of no correspondence to stated emergency duration replace the battery. The replacement of the battery must be done using parts of the same type, by the manufacturer or by a competent person.
6. In case of inactive use for a period greater than 2 months, disconnect the battery by pulling out the battery's connector.
7. **Replaced batteries must not be thrown into trash bins. They must be returned to special battery disposal points. Do not incinerate.**



MOUNTING METHODS

Preparation procedure for ceiling mounting

Attention!!! Interrupt the mains power supply.

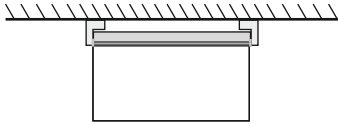
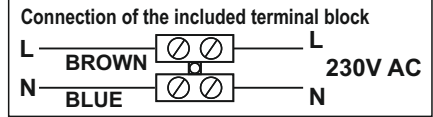

Hanging installation on suspended ceilings using the special mounting brackets contained in the package.



1. Open the pre-etched knock out and pass the cable through.
2. Place the plastic part for mounting the sign.
3. Place the cable holding accessory and mount it by tightening the screw with the included grommet.
4. Connect the wires to the included terminal block and place it in the plastic mounting part.
5. Follow the procedure below (figure 1).

Ceiling Mounting

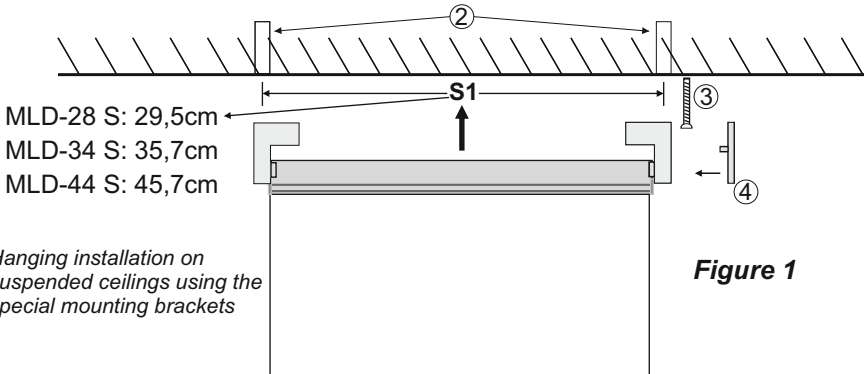
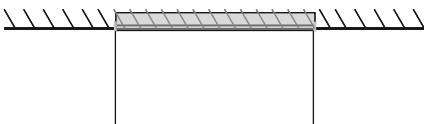

Figure 1

Hanging installation on suspended ceilings using the special mounting brackets

1. **Attention!!!** Choose the installation area to insure that the mounting surface is appropriate for the installation of the illumination sign.
2. Measure the space **S** according to the illumination sign's type and drill the appropriate holes in the ceiling for the installation of the included mounting plugs Nr 6.
3. Place the mounting plugs Nr 6 and mount the sign by tightening the included mounting screws.
4. Refit the plastic cover on each side.
5. Power the illumination sign and check the illumination sign's operation.



Recessed mounted installation on suspended ceilings using the base type A-1018/PL, A-1020/PL, A-1021.

Suspended ceiling mounting bases



A-1018/PL



A-1020/PL

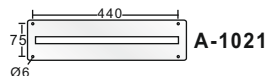

A-1021

Ceiling Mounting

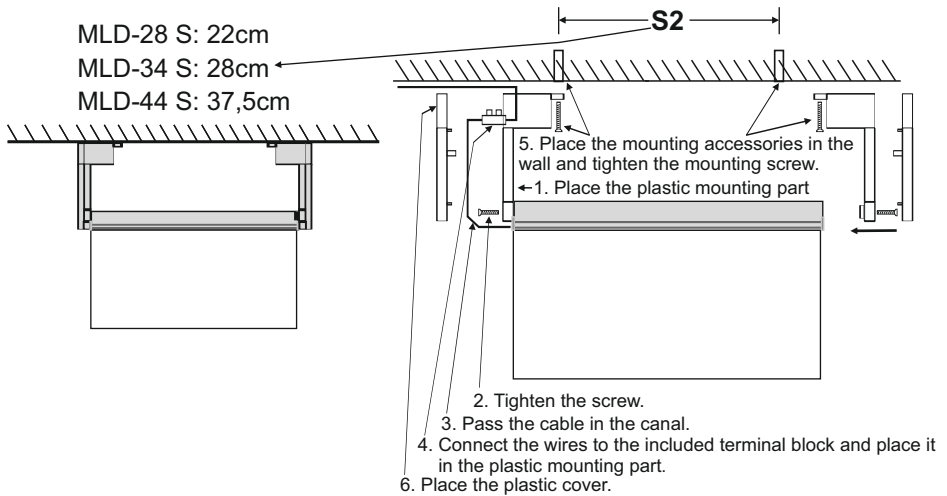

OPTIONAL !!

When a triple core cable must be used, then follow the figures 2,3 below.

Figure 2

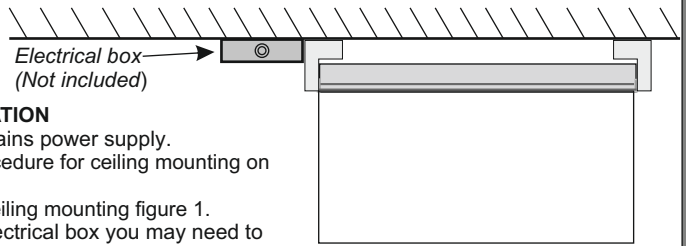

ELECTRICAL BOX INSTALLATION

1. **Attention!!!** Interrupt the mains power supply.
2. Perform the preparation procedure for ceiling mounting on page 2 and exclude step 4.
3. Perform the procedure for ceiling mounting figure 1.
4. For the installation of the electrical box you may need to open holes in the ceiling and at it's cable entrances, for the entrance of the power and illumination sign's cables. Install the electrical box next to the sign so as to cover the cable (figure 2).
5. After mounted the electrical box open the cover and perform the electrical connection according to Figure 3. After the connection close the cover of the box.
6. Power the illumination sign and check the illumination sign's operation.

Use a certified electrical box 250V AC (IP40) to perform the electrical connection, with minimum internal space 35x35x25mm to install the 3 pole terminal block. In this box install a certified 3 pole terminal block 250V AC/16A 2,5mm² providing terminals to connect the live wire L, the neutral N and the ground GND. To this terminal block is connected the power cable with a cross section of 1,5mm². Install the electrical box in an appropriate area in the ceiling. Install securely the 3 pole terminal block and perform the connection according to figure 3.

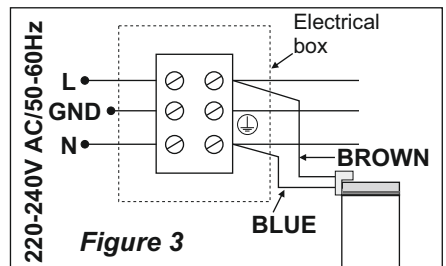

The electrical box and the 3 pole terminal block not included. Installation may require advice from a qualified person.

Wall Mounting

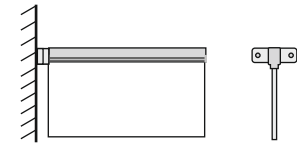

Flag mounted installation on a wall using the special mounting bracket contained in the package.

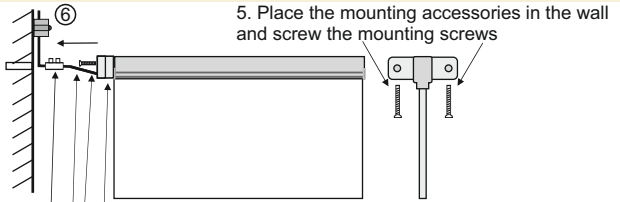

5. Place the mounting accessories in the wall and screw the mounting screws

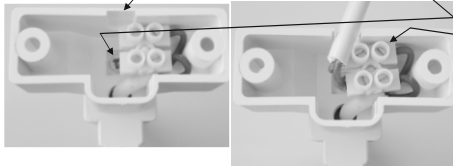

1. Open the pre-etched knock out and pass the cable through.
2. Place the single mounting plastic part
3. Tighten the mounting screw.
4. Connect the wires to the included terminal block and place it in the plastic mounting part.
6. After finishing the installation, secure the cable with a suitable cable detention bracket (not included) to ensure immobilization of the cable at a distance of no more than 5cm from the luminaire's cable entry.

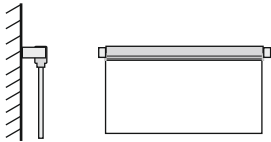

Wall mounted installation using the special mounting brackets contained in the package.

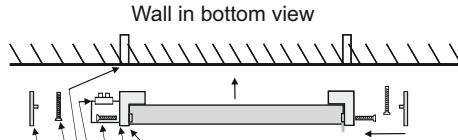
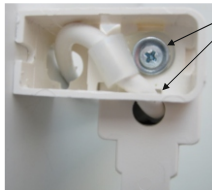

Wall in bottom view

1. Open the pre-etched knock out and pass the cable through.
2. Place the plastic part
3. Place the cable holding accessory and mount it by tightening the screw with the included grommet.
4. Connect the wires to the included terminal block and place it in the plastic mounting part.
5. Place the mounting accessories in the wall and tighten the mounting screw figure 1 step 3.
6. Place the plastic cover.

Electric connection and Eco Light dimensions in mm

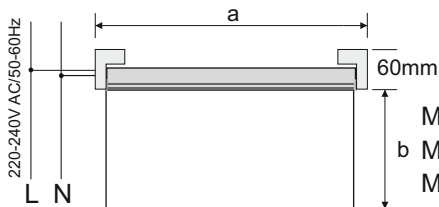

MLD-28 : 305(a) x 95(b)
 b MLD-34 : 365(a) x 165(b)
 MLD-44 : 465(a) x 215(b)

Package contents

The package contains:
 1. The illumination sign
 2. The instructions manual
 3. Plastic bag with supporting materials.

LED MODULE CHARACTERISTICS

	MLD-28S/g	MLD-34S/g	MLD-44S/g
Manufacturer	Olympia Electronics S.A.		
Model Number	1702161	1802161	1902161
Voltage Range	12-14V DC		
Nominal Power	980mW	975mW	
Connections	Fixed connection between main pcb and led module		
Temperature (tc)	40 °C max. across the board		

BATTERY REPLACEMENT PROCESS

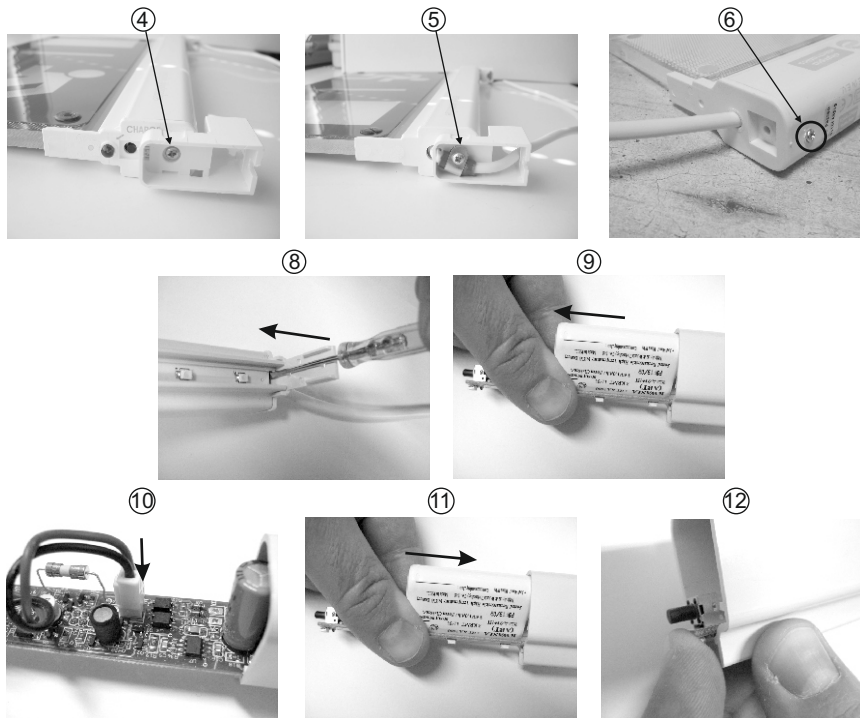

Before service interrupt the mains power supply.

- ① Remove the plastic cover from each side. (figure 1, step 4).
- ② Unfasten the mounting screws to unmount the illumination sign (figure 1, step 2).
- ③ You have to disconnect the power supply wires of the sign from the terminal block.
- ④ Unfasten the mounting screw of the bracket and remove it.
- ⑤ Unfasten the mounting screw (with the cable holding accessory) of the bracket and remove the bracket.
- ⑥ Unfasten the screw without moving the marking panel.
- ⑦ Remove the marking panel.
- ⑧ Slide out the led strip with a flat blade screwdriver.
- ⑨ Pull carefully the led strip by holding it from the two sides as shown on the picture.
- ⑩ Remove the used battery and place a new one with the same type A-939/HT with same cables and connector.
- ⑪ Push carefully the led strip by holding it from the two sides as shown on the picture.
- ⑫ Push the led strip to face the edge of the plastic cover.
- ⑬ **ATTENTION !!! Don't apply force to the test button.**
- ⑭ Refit the removed parts in steps 7,6,5 and 4.
- ⑮ **WARNING!! Use a maximum torque of 0,25Nm to tighten the screws (step 6) and a maximum torque of 0,6Nm to tighten the screws (step 4,5).**
- ⑯ Mount the illumination sign with the mounting screws (figure 1, step 4).
- ⑰ Connect the power supply wires of the sign to the terminal block (step 3). Refit the plastic cover (figure 1, step 5) and power the illumination sign.

NOTE!! After finishing the installation you must power the luminaire at least for 24 hours for battery charging to perform the nominal autonomy.

MAINTAINED TO NON MAINTAINED SELECTION CAPABILITY

Power on the device and press continuously the TEST button for 5 seconds, until the led strip turns off. Release the button and after a short emergency test, the device operates as non-maintained. If you want to restore the previous condition (maintained operation), press continuously the TEST button for 10 seconds, until the led strip lights. Release the button and after a short emergency test, the device operates as maintained illumination sign.

Troubleshooting

Trouble	Solution
1. The illumination sign does not light when the TEST button is pressed.	<p><u>The battery has lost it's energy</u> Wait at least for 1 hour for the battery to be charged.</p> <p><u>The battery is not connected</u> Attach the battery's connector to the appropriate connector on the P.C.B.</p> <p><u>The battery is inappropriate</u> The battery must be replaced.</p>
2. During the 6month autonomous check, the illumination sign does not light or has less autonomy than the nominal.	<p><u>The battery has lost it's energy</u> Wait at least for 24 hours for the battery to be fully charged.</p> <p><u>The battery is inappropriate</u> The battery must be replaced.</p>
3. The illumination sign does not light in normal operation.	<p><u>The illumination sign is adjusted to operate as non-maintained</u> Choose (if you must) to turn the operation to maintained, according to relative paragraph in page 6.</p>
4. The illumination sign does not light during a mains failure.	<p><u>The battery has lost it's energy</u> Wait at least for 24 hours for the battery to be fully charged.</p> <p><u>The battery is not connected</u> Attach the battery's connector to the appropriate connector on the P.C.B.</p> <p><u>The battery is inappropriate</u> The battery must be replaced.</p>

WARRANTY

Olympia Electronics guarantees the quality, condition and operation of the goods. The period of warranty is specified in the official catalogue of Olympia Electronics and also in the technical leaflet, which accompanies each product. This warranty ceases to exist if the buyer does not follow the technical instructions included in official documents given by Olympia Electronics or if the buyer modifies the goods provided or has any repairs or re-setting done by a third party, unless Olympia Electronics has fully agreed to them in writing. Products that have been damaged can be returned to the premises of our company for repair or replacement, as long as the warranty period is valid.

Olympia Electronics reserves the right to repair or to replace the returned goods and to or not charge the buyer depending on the reason of defection. Olympia Electronics reserves the right to charge or not the buyer the transportation cost.

HEAD OFFICE

72nd km. O.N.R. Thessaloniki-Katerini
P.C. 60300 P.O. Box 06 Eginio Pierias Greece
www.olympia-electronics.gr
info@olympia-electronics.gr



The light source contained in this luminaire shall only be replaced by the manufacturer, or his agent, or a similar qualified person.

NOTE! The light source is non-user replaceable.