

# MCR-308

Wireless Interface for Hard-Wire Control Panels



Visonic Ltd

Installation Instructions

## 1. INTRODUCTION

### 1.1 Purpose and Use

The MCR-308 is a wireless PowerCode receiver designed to convert a regular hard-wired control panel into a hybrid wireless system, as demonstrated in Figure 1.

With the MCR-308 serving as an interface between wireless transmitters and the control panel, the control panel's zone inputs "see" regular wired loops, as if they were directly connected to hard-wired devices. The states of the receiver outputs determine whether the control panel's zone inputs are in alarm or not.

A notable feature of the MCR-308 is its compatibility with both regular PowerCode and Code-Secure™ transmitters. Code secure™ transmitters are mainly used to arm/disarm an alarm system or in other control applications, to prevent "code grabbing" by people with malicious intents.

Three operating modes are available:

- **Normal** - the receiver stands by for regular reception
- **Learn** - registration of transmitter and expander IDs in the MCR-308 memory
- **Test** - allows the installer to test the system.

### 1.2 Zone Outputs

The MCR-308 features 4 zone outputs (expandable to 28 outputs - see Para. 1.6). Each zone output can learn the ID codes of up to 4 transmitters/detectors deployed within the protected site (see Para. 1.4 below).

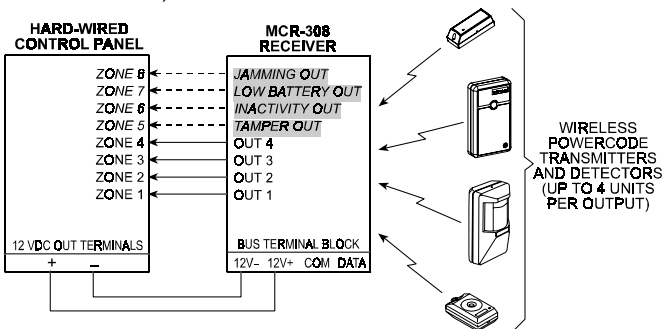

Figure 1. Typical Application of the MCR-308

### 1.3 Status Outputs

In addition to the 4 zone outputs, the MCR-308 provides 4 status outputs that function as follows:

- **Tamper:** This output is activated once a TAMPER state is detected in a transmitter, in an expander unit or in the MCR-308 receiver itself.
- **Inactivity:** This output is activated if a supervised transmitter fails to send its attendance message within a 4-hour time frame, and also upon sensing expander inactivity for 10 seconds.
- **Low Battery:** This output is activated once a low battery message is received from one of the transmitters/detectors. The output is reset by replacing the battery in the transmitter that sent the low battery message and transmitting once again.
- **Jamming:** This output is activated if an interference (channel jamming) is detected on the RF channel for more than 30 seconds. It is reset a few seconds after the jamming stops.

### 1.4 Learning Capability

For proper operation, the MCR-308 must be "taught" the ID code of each wireless transmitter used in the system and of each MCX-8 expander added to the system. Thus, each transmitter is associated with the actual zone output it is meant to trigger

(4 transmitters are allowed per zone output), and each expander (if used) will be recognized by the MCR-308. Detailed teaching/learning procedures are provided in Paragraphs 3.5 and 3.6.

### 1.5 Construction Details

The MCR-308 consists of a motherboard that accommodates the processing circuitry and the RF receiver module. The entire assembly is packaged in a plastic two-part cabinet, with vacant space for an expander module that adds 8 outputs to the receiver (see details in Paragraph 1.6).

A semi-rigid vertical antenna is connected to a special screw terminal located at the top edge of the motherboard.

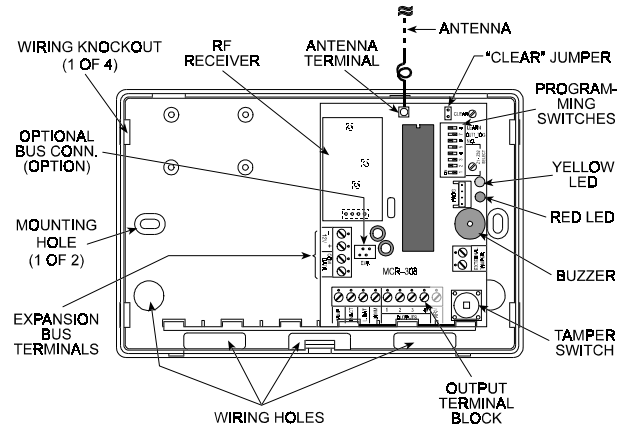

Figure 2. MCR-308 with Cover Removed

### 1.6 System Expansion Option

Although the MCR-308 provides only 4 zone outputs, its span of control can be increased by adding MCX-8 expander modules, connected via a 4-wire expansion bus (see Figure 3).

Three expanders may be added to a single MCR-308 unit. Each expander provides 8 additional outputs, and together with the 4 zone outputs of the MCR-308 the total number of zone outputs will amount to 28.

Twenty eight zone outputs multiplied by four wireless devices per output produce a total of 112 differently coded wireless devices that can be used in a single system.

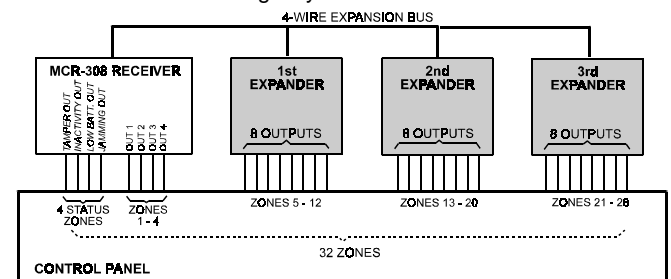

Figure 3. Expanded System Configuration

### 1.7 LED Functions during Operation

The MCR-308 has two LED indicators:

- The SIGNAL indicator (red)
- The TROUBLE indicator (yellow)

**SIGNAL indicator:** This LED lights steadily for 2 seconds upon reception of a valid message. If noise or unrecognizable RF signal are received, the LED flickers.

**TROUBLE indicator:** This LED is extinguished while all is well, but lights steadily for as long as the TAMPER, LOW BATTERY and INACTIVITY outputs are activated.

The trouble indicator will remain lighted until all trouble is cleared (restore/attendance messages arrive from all trouble sources).

**Note:** Both indicators have other functions during a learning session (see Paragraphs 3.5 and 3.6).

## 2. SPECIFICATIONS

### RF SECTION

**Front-End Module:** Superheterodyne UHF receiver.  
**Operating Frequency:** Per local requirements in country of use.

### DATA PROCESSING SECTION

**ID codes:** Over 16,000,000 possible 24-bit combinations.  
**Total Message Length:** 36 bits (66 bits for code secure devices)  
**ID Learning Capacity:** 112 different ID codes  
**Expander Bus:** 4-wires (12V+, [-], DATA and COMMON)

### ELECTRICAL DATA

**Zone Outputs:** 4, up to 100 mA each, open-collector type  
**Status outputs:** 4, up to 100 mA each, open-collector type  
**Output Polarities:** N.O. or N.C., selected with DIP switch  
**Output No. 1 modes:** Pulsed (2 seconds) or toggle, selected with DIP switch

**Tamper Switch Ratings:** 0.1 A / 30 VDC.

**Input Voltage Range:** 10.5 - 16 VDC

**Current Drain (@ 12 VDC):** 45 mA

### PHYSICAL

**Operating Temperatures:** 0°C to 49°C (32° F to 120° F).  
**Dimensions (H x W x D):** 108 x 165 x 38 mm (4-1/4 x 6-1/2 x 1-1/2").  
**Weight (including rigid antenna):** 214 g (7.5 oz).  
**Compliance with Standards:** Designed to meet FCC part 15, ETS 300-220, ETS 300-683 and MPT 1340 requirements.

### AUXILIARY EQUIPMENT

**MCX-8:** Eight-output zone expander unit.

## 3. PROGRAMMING

### 3.1 Helpful Hints

A learning session is required to let the MCR-308 learn the ID codes of individual wireless transmitters and link each transmitter to a specific output (up to 4 transmitters per output).

In addition, it is necessary to register in the receiver's memory the ID code of any MCX-8 expander used in the system. If these codes are not "learned", the expanders will not function.

The quickest way to conduct a learning session is on a work bench, with every transmitter you need within reach, and where you may observe the receiver's indicator LEDs and listen to the buzzer.

### 3.2 Initial Steps

- A. Remove the screw that secures the cover to the base and remove the cover as shown in Figure 4.

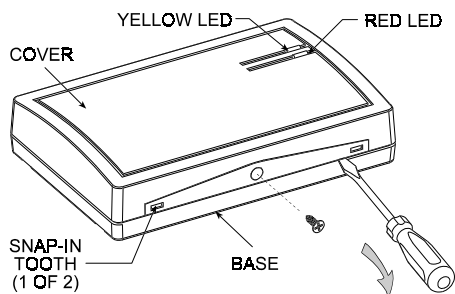

Figure 4. Removing the Top Cover

- B. The semi-rigid antenna supplied with the MCR-308 is taped to the inner part of the cover. Detach the antenna from its storage position, insert its straight tip into the antenna terminal and **tighten the screw well**. See Figure 2 for antenna terminal location.
- C. Gather up all transmitters used in the system and mark each one according to the desired deployment plan.
- D. Temporarily power up the MCR-308 by connecting a 12 V battery or a 12 VDC power supply across its 12 V input terminals. **Observe polarity!**

### 3.3 Selecting the Target Zone Output

In order to link a transmitter to a specific zone output, you must first select the desired output number by setting DIP switches SW1 through SW-5 as shown in Table 1. A (-) sign indicates an off position of the switch.

Table 1. Output Selection Chart

Zone Output #	DIP Switches					Wired Output Selected
	1	2	3	4	5	
<b>MCR-308</b>						
1	ON	-	-	-	-	Output No. 1
2	-	ON	-	-	-	Output No. 2
3	ON	ON	-	-	-	Output No. 3
4	-	-	ON	-	-	Output No. 4
<b>1<sup>ST</sup> EXPANDER</b>						
5	ON	-	ON	-	-	Output No. 1
6	-	ON	ON	-	-	Output No. 2
7	ON	ON	ON	-	-	Output No. 3
8	-	-	-	ON	-	Output No. 4
9	ON	-	-	ON	-	Output No. 5
10	-	ON	-	ON	-	Output No. 6
11	ON	ON	-	ON	-	Output No. 7
12	-	-	ON	ON	-	Output No. 8
<b>2<sup>ND</sup> EXPANDER</b>						
13	ON	-	ON	ON	-	Output No. 1
14	-	ON	ON	ON	-	Output No. 2
15	ON	ON	ON	ON	-	Output No. 3
16	-	-	-	-	ON	Output No. 4
17	ON	-	-	-	ON	Output No. 5
18	-	ON	-	-	ON	Output No. 6
19	ON	ON	-	-	ON	Output No. 7
20	-	-	ON	-	ON	Output No. 8
<b>3<sup>RD</sup> EXPANDER</b>						
21	ON	-	ON	-	ON	Output No. 1
22	-	ON	ON	-	ON	Output No. 2
23	ON	ON	ON	-	ON	Output No. 3
24	-	-	-	ON	ON	Output No. 4
25	ON	-	-	ON	ON	Output No. 5
26	-	ON	-	ON	ON	Output No. 6
27	ON	ON	-	ON	ON	Output No. 7
28	-	-	ON	ON	ON	Output No. 8

### 3.4 Selecting Sub-Zone Locations

Each zone output is divided into 4 sub-zones, and each sub zone accepts one transmitter ID. Sub zone locations may be selected in ascending order from 1 to 4, by clicking the MCR-308's tamper switch (a short beep will sound upon each click).

The yellow LED will indicate the ordinal number of the selected sub-zone location by a flashing sequence as demonstrated in the following chart:

No. of Clicks	Sub-Zone	Flashing Sequence of the Yellow LED
One	1 <sup>st</sup>	☀ — ☀ — ☀ .....
Two	2 <sup>nd</sup>	☀☀ — ☀☀ — ☀☀ .....
Three	3 <sup>rd</sup>	☀☀☀ — ☀☀☀ — ☀☀☀ .....
Four	4 <sup>th</sup>	☀☀☀☀ — ☀☀☀☀ — ☀☀☀☀ .....

☀ = Flash; — = Pause

### 3.5 Learning Transmitter IDs

A single transmission is required to register a transmitter ID in the MCR-308 memory.

#### A. Preparations

- Prepare all the transmitters and mark each one with the desired target **zone output** and **sub zone location**.

**Note:** In case of PIR detectors in which batteries are already installed, cover the detector's lens to prevent accidental transmission during the learning session.

- Remove the MCR-308 cover. The buzzer will beep once upon release of the tamper switch.

#### B. Transmitter Learning Procedure

- Set DIP switch SW-8 to ON (LEARN mode). The **yellow** LED will flash at a constant rate throughout the learn period.
- Use DIP switches 1 through 5 to select the desired zone output (see Table 1).
- Click the MCR-308 tamper switch 1 or 2 or 3 or 4 times to select the desired sub-zone (see Para. 3.4). Each click advances to the next sub-zone. The status of the selected sub-zone location will be shown by the **red** LED:

Status	Red LED Response
Location is free	LED Flashes
Location already contains an ID	LED Lights steadily

To clear a "busy" location, refer to Para. 3.7.

- If the sub-zone location is free, initiate a transmission from the transmitter you wish to enroll in the selected sub zone. The red LED and the buzzer can respond as follows:

Red LED & Buzzer Response	Significance
Red LED: lights steadily; Buzzer: "victory melody" (🔔🔔🔔🔔)	Transmitter ID enrolled
Red LED: lights steadily; Buzzer: "victory melody" (🔔🔔🔔🔔) <i>twice</i>	Transmitter ID enrolled <b>again</b> (the same ID is already saved in another location)
Red LED: continues to flash; Buzzer: remains silent	Transmitter ID <b>not enrolled</b>

**Note:** You can not enroll a transmitter in a busy location. However, if you try to enroll a transmitter in a busy location, and the same ID is already enrolled in another location, the buzzer will sound a long beep.

- Repeat Steps 2 through 4 above for all the remaining transmitters.
- When done, quit the LEARN mode by setting SW-8 to OFF.

**Notes:** 1. If the transmitter used is a wireless detector, remove its battery to prevent accidental transmissions at a later stage of the learning session.

2. If you leave SW-8 in the ON position and no further learning activity takes place for 5 minutes, the LEARN mode will be automatically abandoned.

#### C. Memory Content Verification

To check whether a specific transmitter's ID is programmed in a certain zone, select the zone output and then the sub-zone in question and initiate a transmission. If the saved and transmitted IDs match, the buzzer will sound the victory melody (🔔🔔🔔🔔).

If there is no match but the same ID is already enrolled in another sub-zone location, the buzzer will sound a long beep. If the ID is not recognized by the MCR-308, the buzzer will remain silent.

### 3.6 Learning Expander IDs

It is necessary to "teach" the MCR-308 which expander is related to which group of zone outputs. The expander's specific ID must therefore be programmed into special expander locations in the MCR-308 memory.

#### A. Preparations

- Connect the expander (or expanders) to the expansion bus.
- Remove the MCR-308 cover. The buzzer will beep once upon release of the tamper switch.

#### B. Expander Learning Procedure

- Set DIP switch SW-8 to ON (LEARN mode). The **yellow** LED will flash at a constant rate throughout the learn period.
- Use DIP switches 1 through 5 to select the desired expander memory location as shown in Table 2 below:

Table 2. Expander Location Selection Chart

Expander Module	DIP Switches					Related Zone Outputs
	1	2	3	4	5	
1 <sup>st</sup>	ON	—	ON	ON	ON	Zones 5 - 12
2 <sup>nd</sup>	—	ON	ON	ON	ON	Zones 13 - 20
3 <sup>rd</sup>	ON	ON	ON	ON	ON	Zones 21 - 28

- Click the MCR-308 tamper switch once. The status of the selected expander memory location will be shown by the **red** LED:

Status	Red LED Response
Location is free	LED Flashes
Location already contains an ID	LED Lights steadily

To clear a "busy" location, refer to Para. 3.7 below.

- Click the expander's tamper switch once. The red LED and the buzzer will respond as follows:

Red LED & Buzzer Response	Significance
Red LED: lights steadily; Buzzer: "victory melody" (🔔🔔🔔🔔)	Expander ID enrolled
Red LED: flashes at a constant rate Buzzer: remains silent	Expander ID <b>not enrolled</b>

**Note:** If not enrolled, check the connections to the bus.

- Repeat steps 2 and 3 above for all other expanders. When done, quit the LEARN mode by setting SW-8 to OFF.

#### C. Expander ID Verification

To check whether a specific expander's ID is properly programmed, use DIP switches 1 through 5 to select the expander location in question (see Table 2 above). Click the expander's tamper switch once to send its ID to the MCR-308. If the programmed and transmitted IDs match, the buzzer will sound the victory melody (🔔🔔🔔🔔).

### 3.7 Clearing Specific Transmitter or Expander IDs

- Set DIP switch SW-8 to ON (LEARN mode). The **yellow** LED will flash at a constant rate throughout the learn period.

- Use DIP switches 1- 5 to select the desired zone output (see Table 1) or the expander module location (see Table 2).

**Note:** If you are clearing a transmitter ID, click the MCR-308 tamper switch 1 or 2 or 3 or 4 times to select the desired sub zone location (see Para. 3.4). If you are about to clear an expander's ID, click the MCR-308 tamper switch only once.

The status of the selected sub-zone location will be shown by the **red** LED:

Status	Red LED Response
Sub-zone or expander location is free	LED Flashes
Sub-zone or expander location already contains an ID	LED lights steadily

- Mount a jumper across the two CLEAR pins on the MCR-308 circuit board and remove it immediately. The red LED and the buzzer will respond as follows:

Response	Significance
Red LED: flashes at a constant rate Buzzer: "victory melody" (🔔🔔🔔)	Success (ID deleted)
Red LED: continues to light steadily Buzzer: silent	Failure

D. When done, quit the LEARN mode by setting SW-8 to OFF.

### 3.8 Global Clearing of the ID memory

Global clearing provides you with a quick fresh start if your MCR-308 has been used in another system, or has been "played with" as part of an experiment.

**IMPORTANT! You must be prepared to perform the second step of the following procedure within 10 seconds from the first step, while the buzzer is still beeping.**

## 4. INSTALLATION

### 4.1 Selecting the Location

- The location selected for the MCR-308 must constitute a compromise between maximum reception ability and minimum distance from the control panel.
- The expanders may be located within the control panel's cabinet (if there is enough room) or near it.
- It is very important to maintain the antenna vertical - the receiver should be installed with the antenna on top, as shown in Figure 2.
- Avoid installing the MCR-308 on or near large metallic objects such as closets, circuit breaker cabinets, air conditioner ducts and fine-mesh window screens.
- Do not locate the unit in close proximity to dense electrical wiring.

### 4.2 Mounting the Cabinet in Place

To install the cabinet, proceed as follows:

- Hold the base against the mounting surface and mark the points for drilling (see mounting holes in Figure 2).
- Drill the mounting holes and insert wall anchors if necessary. Enter the wires into the base through the wiring holes or wiring knockouts. Attach the base to the mounting surface with two long screws.
- Complete the wiring as described in Para. 4.3.

### 4.3 Wiring (Figures 5 and 6)

- Connect the 4 zone outputs (1, 2, 3, and 4) of the MCR-308 to the desired zone inputs of the control panel in use.

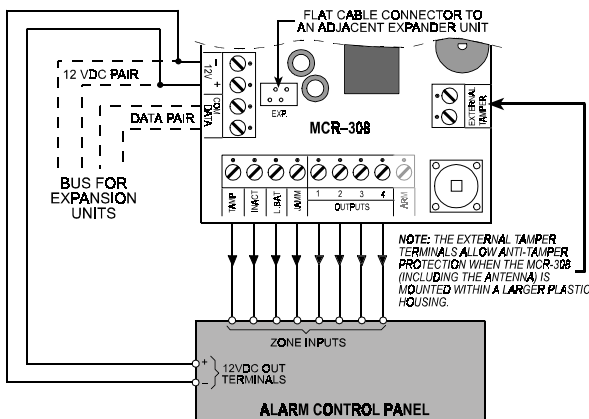

Figure 5. Wiring Diagram

- Connect the four status outputs of the MCR-308 (TAMP, INACT, L. BAT and JAM) to the desired zone inputs of the control panel in use.

**Note:** If the control panel zone inputs are defined as E.O.L., you must use appropriate E.O.L. resistors (see Figure 6).

- Remove the cover from the MCR-308. Disconnect the power, wait a few seconds and reconnect the power. This will cause the buzzer to beep 10 times - 1 beep per second.
- Within the limit of the above-mentioned 10 seconds, mount a jumper across the two CLEAR pins, remove it immediately and then mount and remove quickly again. When done, the buzzer will start a series of rapid beeps, at the end of which the "victory melody" (🔔🔔🔔) will sound. All transmitter and expander IDs will thus be cleared from the memory.

### 3.9 What Can be Done if the ID is not Enrolled?

If the transmitted ID has not been accepted (the buzzer remains silent) although the memory location is free, try transmitting again. If the second attempt is unsuccessful, the transmitter in question may be faulty. Try enrolling another transmitter.

- Connect the control panel's 12 VDC (+) and (-) terminals to their counterparts on the left edge of the MCR-308 module.
- If an expander is mounted within the MCR-308 case, connect it to the MCR-308 using the flat cable (supplied with the expander) between the flat cable receptacles on both units. If an expander is mounted away from the MCR-308 in a separate enclosure, use the four bus terminals on both units, connecting each terminal to its counterpart in the other unit

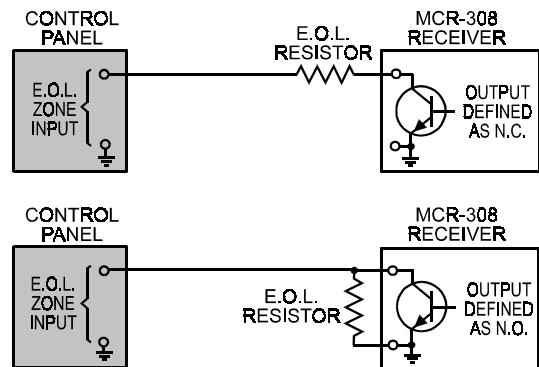

Figure 6. Wiring E.O.L. Zones

- Make sure the antenna is firmly held in place near the top edge of the PCB.

### 4.4 Customizing Your Receiver

After wiring, it is necessary to set DIP switches 6, 7 and 8 as required for the specific application (see Figure 7).

- Make sure that SW-8 is OFF - the regular operation mode is selected.
- DIP switch SW-6 determines the zone output polarity (N.O. or N.C.):

SW-6 Setting	Result
ON	The MCR-308 zone outputs are N.O.
OFF	The MCR-308 zone outputs are N.C.

Set the switch as required for your particular application.

- DIP switch SW-7 determines the operating mode of zone output No. 1 (Momentary or Toggle):

SW-7 Setting	Result
ON	Zone output 1 operates in the <b>toggle</b> mode
OFF	Zone 1 operates in the <b>momentary</b> mode

**Note:** Zone No. 1 can be used for Arming/Disarming purposes or for other remote control tasks such as switching lights ON and OFF.

Figure 7 can serve as a quick reference to DIP switch tasks.



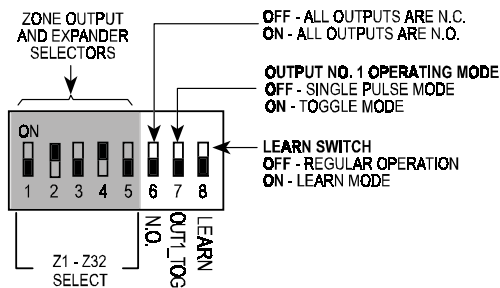

Figure 7. DIP Switch Tasks and Positions

## 4.5 Testing the Wireless System

Testing the system is the best way to find out:

- Which transmission is received properly (good reception)
- Which transmission is received marginally (poor reception)
- Which transmitter has a low battery status

The system should be tested at least once in 6 months, to assure proper operation of the wireless communication links.

- Remove the MCR-308 cover. The test mode is selected automatically when the tamper contacts open. The buzzer will sound a single beep upon release of the tamper switch.
- Initiate a transmission from all transmitters, one by one, but allow at least 5 seconds between transmissions. The buzzer will react as follows:

Reception Grade	Buzzer Reaction
Good	Victory melody (🎵🎵🎵)
Poor	1-second beep (🔔)
Low Battery in Transmitter*	4-second beep (🔔🔔🔔🔔)

\* Regardless of good or poor reception.

- When done, remount the MCR-308 top cover. This will cause the receiver to quit the test mode.

## 5. MISCELLANEOUS COMMENTS

### 5.1 The Effect of Transmitter Type on Alarm Output Behavior

The PowerCode system allows the MCR-308 to make a distinction between devices that report alarm only (such as PIR detectors and pendant transmitters) and detectors such as magnetic switches that report both alarm and restore.

The MCR-308 responds to an alarm transmitted by devices that report alarm only by changing the state of the associated output for 2 seconds and then restoring it to the previous state.

An alarm message transmitted by restoral-reporting device "tells" the receiver to expect a restoral message after an alarm. The MCR-308 will change the state of the associated output upon alarm from one sub-zone or more, and will maintain the output in alarm. The output will revert to its original state only upon reception of a restoral message from the alarming sub-zone or (or from all alarming sub-zones in case of multiple alarms).

### 5.2 The Effect of Transmitter Type on the Inactivity (INACT) Output

The PowerCode system allows the MCR-308 to make a distinction between supervised and non-supervised transmitters.

Supervised transmitters transmit an "attendance message" at regular intervals. If a supervised transmitter fails to send this message on time, the MCR-308 will trigger the INACT output.

On the other hand, failure to receive an attendance message from a transmitter identified as a non-supervised device will be ignored by the MCR-308.

### 5.3 Product Limitations

Visonic Ltd. wireless systems are very reliable and are tested to high standards. However, due to their low transmitting power and limited range (required by FCC and other regulatory authorities), there are some limitations to be considered:

- Receivers may be blocked by radio signals occurring on or near their operating frequencies.
- A receiver can only receive one transmitted signal at a time.
- Wireless equipment should be tested regularly to determine whether there are sources of interference and to protect against faults.

The user is cautioned that changes or modifications to the unit, not expressly approved by Visonic Ltd., could void the user's FCC authority to operate the equipment.

## WARRANTY

Visonic Ltd. and/or its subsidiaries and its affiliates ("the Manufacturer") warrants its products hereinafter referred to as "the Product" or "Products" to be in conformance with its own plans and specifications and to be free of defects in materials and workmanship

for normal use and service for a period of twelve months from the date of shipment by the Manufacturer. The Manufacturer's obligations shall be limited within the warranty period, at its option, to repair or replace the product or any part thereof. The Manufacturer shall not be responsible for dismantling and/or reinstallation charges. To exercise the warranty the product must be returned to the Manufacturer freight prepaid and insured.

**This warranty does not apply in the following cases:** improper installation, misuse, failure to follow installation and operating instructions, alteration, abuse, accident or tampering, and repair by anyone other than the Manufacturer.

This warranty is exclusive and expressly in lieu of all other warranties, obligations or liabilities, whether written, oral, express or implied, including any warranty of merchantability or fitness for a particular purpose, or otherwise. In no case shall the Manufacturer be liable to anyone for any consequential or incidental damages for breach of this warranty or any other warranties whatsoever, as aforesaid.

This warranty shall not be modified, varied or extended, and the Manufacturer does not authorize any person to act on its behalf in the modification, variation or extension of this warranty. This warranty shall apply to the Product only. All products, accessories or attachments of others used in conjunction with the Product, including batteries, shall be covered solely by their own warranty, if any. The Manufacturer shall not be liable for any damage or loss whatsoever, whether directly, indirectly, incidentally, consequentially or otherwise, caused by the malfunction of the Product due to products, accessories, or attachments of others, including batteries, used in conjunction with the Products.

The Manufacturer does not represent that its Product may not be compromised and/or circumvented, or that the Product will prevent any death, personal and/or bodily injury and/or damage to property resulting from burglary, robbery, fire or otherwise, or that the Product will in all cases provide adequate warning or protection. User understands that a properly installed and maintained alarm may only reduce the risk of events such as burglary, robbery, and fire without warning, but it is not insurance or a guarantee that such will not occur or that there will be no death, personal damage and/or damage to property as a result.

**The Manufacturer shall have no liability for any death, personal and/or bodily injury and/or damage to property or other loss whether direct, indirect, incidental, consequential or otherwise, based on a claim that the Product failed to function.** However, if the Manufacturer is held liable, whether directly or indirectly, for any loss or damage arising under this limited warranty or otherwise, regardless of cause or origin, the Manufacturer's maximum liability shall not in any case exceed the purchase price of the Product, which shall be fixed as liquidated damages and not as a penalty, and shall be the complete and exclusive remedy against the Manufacturer.

**Warning:** The user should follow the installation and operation instructions and among other things test the Product and the whole system at least once a week. For various reasons, including, but not limited to, changes in environmental conditions, electric or electronic disruptions and tampering, the Product may not perform as expected. The user is advised to take all necessary precautions for his/her safety and the protection of his/her property.

6/91



VISONIC LTD. (ISRAEL): P.O.B 22020 TEL-AVIV 61220 ISRAEL. PHONE: (972-3) 645-6789, FAX: (972-3) 645-6788  
 VISONIC INC. (U.S.A.): 10 NORTHWOOD DRIVE, BLOOMFIELD CT. 06002-1911. PHONE: (860) 243-0833, (800) 223-0020 FAX: (860) 242-8094  
 VISONIC LTD. (UK): UNIT 1, STRATTON PARK, DUNTON LANE, BIGGLESWADE, BEDS. SG18 8QS. PHONE: (01767) 600857 FAX: (01767) 601098  
 ©VISONIC LTD. 1998 MCR-308 DE3191- (REV. 1, 10/98)



MADE IN ISRAEL

# Transmitter Deployment Table

Zone Output	Sub-Zone	Type of Transmitting Device	Location / Task / Name of Holder
1	1		
	2		
	3		
	4		
2	1		
	2		
	3		
	4		
3	1		
	2		
	3		
	4		
4	1		
	2		
	3		
	4		
5	1		
	2		
	3		
	4		
6	1		
	2		
	3		
	4		
7	1		
	2		
	3		
	4		
8	1		
	2		
	3		
	4		
9	1		
	2		
	3		
	4		
10	1		
	2		
	3		
	4		
11	1		
	2		
	3		
	4		
12	1		
	2		
	3		
	4		
13	1		
	2		
	3		
	4		
14	1		
	2		
	3		
	4		