

Specifications

Model	HX-80N	HX-80NAM
Detection method	Passive infrared	
Anti-masking	-	✓
PIR Coverage	24.0 m × 2.0 m (80' × 6'7") narrow / 20 zones	
PIR distance limit	6.5 m, 10.0 m, 13.0 m, 18.0 m (22', 33', 42', 59')	
Detectable speed	0.3 m/s - 1.5 m/s (1'/s - 4'11"/s)	
Sensitivity	2.0°C (3.6°F) at 0.6 m/s	
Power input	9.5 - 18 V DC	
Current draw	35 mA (max.) at 12 V DC	40 mA (max.) at 12 V DC
Alarm period	2.0 ± 1 sec.	
Warm-up period	Approx. 60 sec. (LED blinks)	
Alarm output	Form C 28 V DC 0.2 A (max.)	
Tamper output	N.C. 28 V DC, 0.1 A (max.) N.C. open when cover removed.	
Trouble output	-	N.C. 28 V DC, 0.1 A (max.)
Aux input	N.C. 28 V DC, 0.1 A (max.)	
LED indicator	Red: Warm-up, Alarm	Red: Warm-up, Alarm, Trouble
RF interference	No alarm 10 V/m	
Operating temperature	-20 - +60°C (-4 - +140°F)	
Environment humidity	95% max.	
Weatherproof	IP55	
Mounting	Wall	
Mounting height	2.5 - 3.0 m (8'2" - 9'10")	
Bracket adjust angle	Vertical: ±20° Horizontal: ±95°	
Weight	720 g (25.4 oz.)	
Accessories	Bracket, Screw (4 × 20 mm) × 4	

Model	HX-80NRAM
Detection method	Passive infrared
Anti-masking	✓
PIR Coverage	24.0 m × 2.0 m (80' × 6'7") narrow / 20 zones
PIR distance limit	6.5 m, 10.0 m, 13.0 m, 18.0 m (22', 33', 42', 59')
Detectable speed	0.3 m/s - 1.5 m/s (1'/s - 4'11"/s)
Sensitivity	2.0°C (3.6°F) at 0.6 m/s
Power input	3 - 7.2 V DC Lithium Battery (CR123A×3, CR2×3, 1/2AA×3, 1/2AA×6)
Operating voltage	2.5 - 9 V DC
Current draw	30 μA (standby) / 4 mA (max.) at 3 V DC
Alarm period	2.0 ± 1 sec.
Warm-up period	Approx. 90 sec. (LED blinks)
Alarm output	Form C -Solid State Switch- 10 V DC 0.01 A max.
Trouble output	N.C./N.O. Selectable -Solid State Switch- 10 V DC 0.01 A max.
Tamper output	Form C, 28 V DC, 0.1 A max. activates when cover removed.
LED indicator	Disable: During normal operation. Enable: During WALK TEST or LED SW on. Red: Warm-up, Alarm, Trouble, Low battery
RF interference	No alarm 10 V/m
Operating temperature	-20 - +60°C (-4 - +140°F)
Environment humidity	95% max.
Weatherproof	IP55
Mounting	Wall
Mounting height	2.5 - 3.0 m (8'2" - 9'10")
Bracket adjust angle	Vertical: ±20° Horizontal: ±95°
Weight	780 g (27.5 oz.)
Accessories	Bracket, Screw (4 × 20 mm) × 4, Velcro tape × 2, Alarm cable, Battery lead × 2, Dummy battery kit

*Specifications and designs are subject to change without prior notice.
*Batteries and wireless transmitters are not included these products.

Coverage

Top view

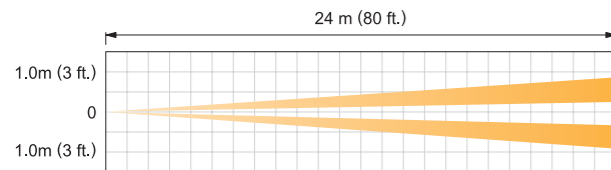

Side view

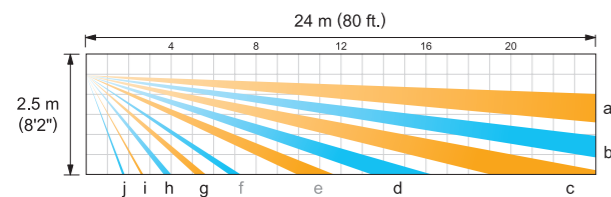
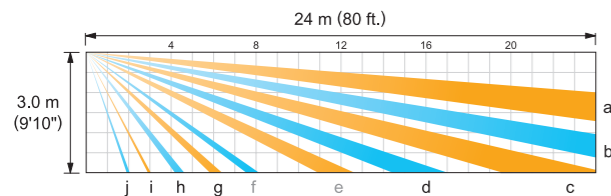

Dimensions

Using bracket

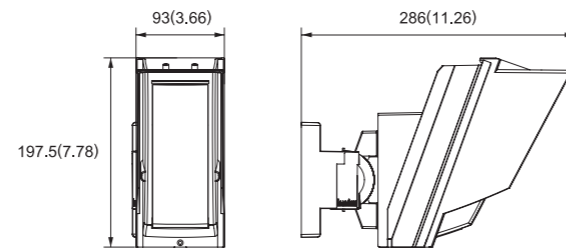

Without bracket

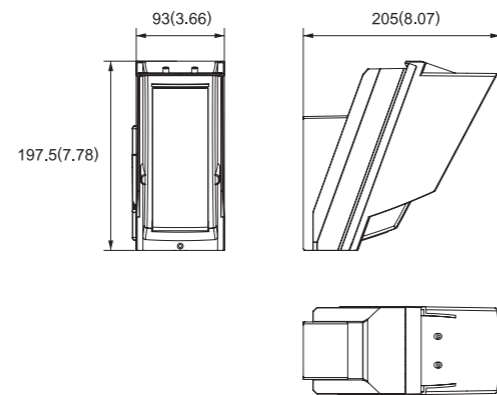

mm (inch)

24m Long and Narrow range High mount Outdoor detector

HX-80N series



Introducing No.1
OPTEX advantage

- HX-80N** : 2 PIRs standard model
- HX-80NAM** : Anti-masking model
- HX-80NRAM** : Battery operated model



OPTEX CO., LTD. (ISO 9001 Certified / ISO14001 Certified)
5-8-12 Ogoto, Otsu, Shiga, 520-0101 Japan
TEL +81(0)77 579 8670 FAX +81(0)77 579 8190 <http://www.optex.co.jp/e/>

OPTEX INCORPORATED (USA) <http://www.optexamerica.com/>

OPTEX (EUROPE) LTD. (UK) <http://www.optex-europe.com/>
(ISO9001 Certified)

OPTEX SECURITY SAS (FRANCE) <http://www.optex-security.com/>

OPTEX KOREA CO., LTD. (KOREA) <http://www.optexkorea.com/>

OPTEX SECURITY Sp. z o.o. (POLAND) <http://www.optex.com.pl/>

OPTEX (DONGGUAN) CO., LTD. <http://www.optexchina.com/>

Shenzhen office (CHINA)

24m/80ft. Closing time for intruders

We are bringing down the curtain.

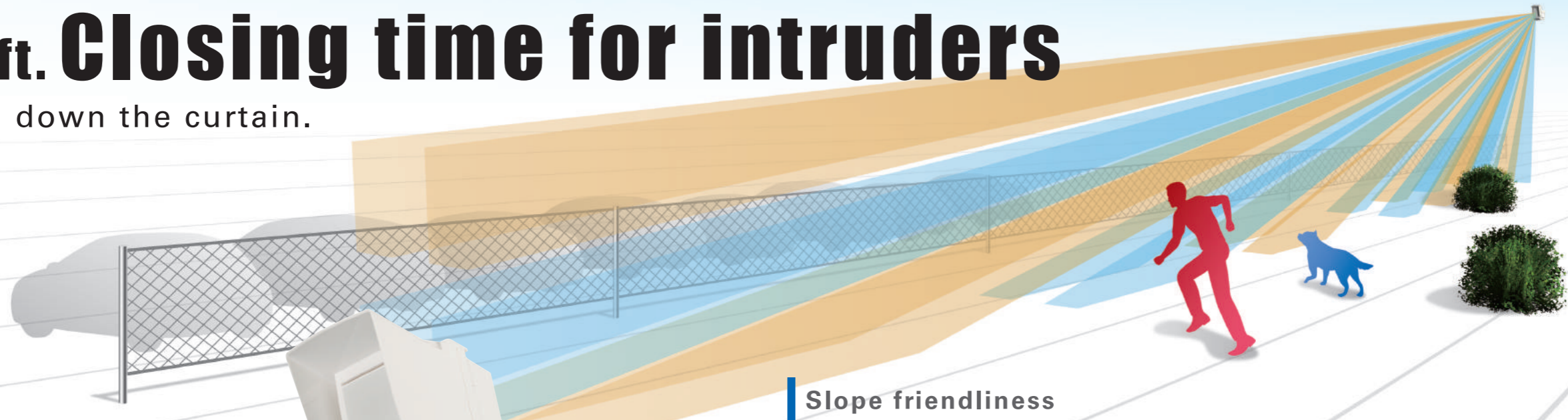

Product features

Catch performance



The HX Series features superb Catch Performance. The most important element in reliable outdoor detector is accuracy to distinguish a human from a small animal. The exclusive pyro element on board enables the HX to project an ideal detection pattern, thus allowing for more accurate detection of humans and less false alarms.

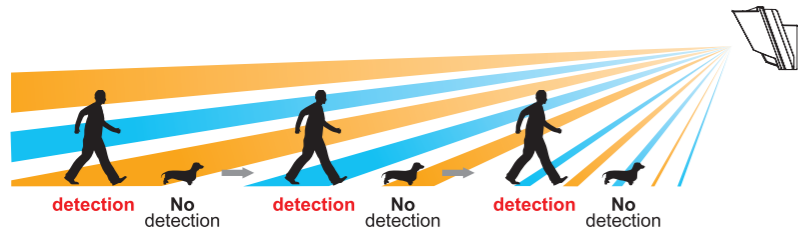

HX-80N 2 PIRs standard model



Slope friendliness

Not all outdoor ground is flat like most indoor environments. Steep slopes can cause negative effects on the catch performance feature. The adjustable included bracket enables the HX to maintain the optimal catch performance.

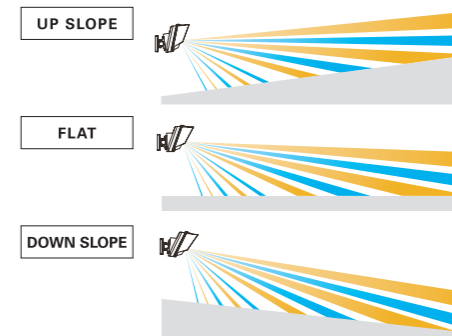

180° horizontal angle adjustable bracket

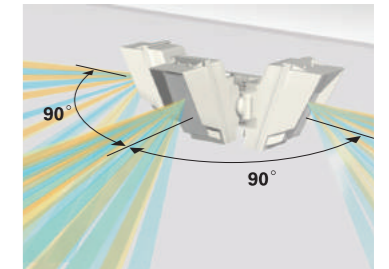

Adjustability

HX coverage can be adjusted by means of built-in flaps and plates

Flaps for long distance limit

To adjust the long range of detection, set the upper and lower flaps.

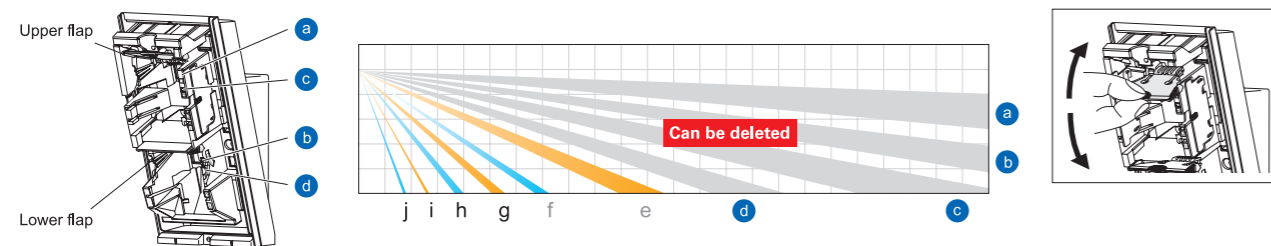

Plates for short range masking

To adjust the short range of detection, set the masking plates.

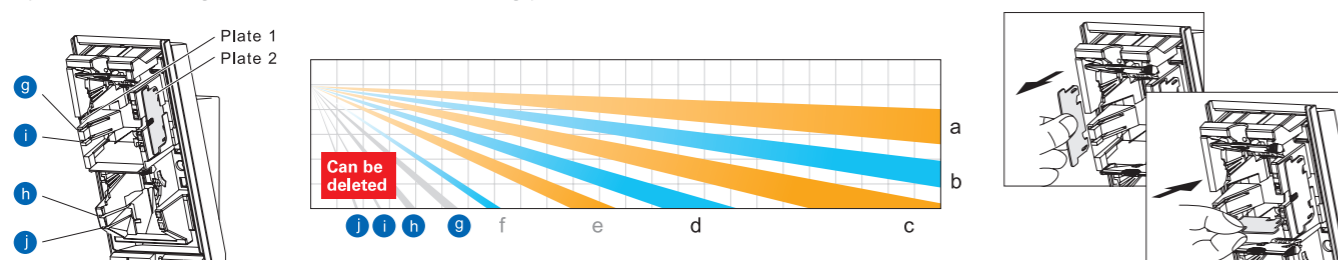

* Plate 1 and 2 are identical.

Basic Performance

- Mounting height 2.5-3.0m
- Intelligent AND detection logic with unique pyro-element
- Double conductive shielding
- Advanced temperature compensation logic
- Summer night compensation logic
- Vegetation sway analysis logic

Product line up

HX-80NAM Anti-masking

HX-80NRAM Battery operated model

Active IR digital anti-masking

When an object is placed close to the lens surface, for a period of more than 180 seconds, the IR Anti-Masking circuit will activate and generate a trouble signal.



Save installation time and cost.

HX-80NRAM is battery operated model therefore requires no complicated wiring.



Battery box for numerous battery types

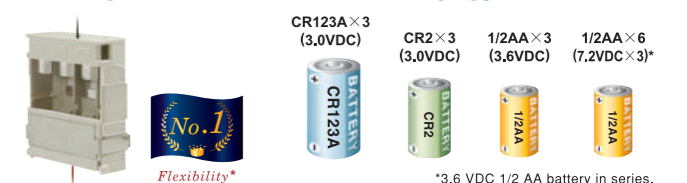

*3.6 VDC 1/2 AA battery in series.

Application



Residential site



Commercial site



Storage site

*According to our survey on November, 2010.