

Environ WR500 Wall Rack 6U x 600 mm Wide x 500 mm Deep - Black

Item Code: WB6.5SGB

excel
without compromise.



✕ Choice of depths available

✕ Choice of colours available

✕ Supplied assembled or flat packed

✕ Aesthetically pleasing framed safety glass front door

✕ Quick release doors and side panel

✕ Adjustable front and rear 19" mounting profiles

Product Overview

The Environ WR is a range of wall-mounted 500mm wide racks designed for the installation of both cabling and equipment, suitable for a wide range of applications including local area networking (LAN) cabling and hardware, and the housing of security, audio and visual equipment.

Product Specifications

Feature	Values
Mounting Profile	Front and rear
Model	With permanent frame
Type of profile rail	L-shaped
Number of doors	1
Type of ventilation	Passive
Width	600 mm
Height	368 mm
Depth	500 mm
Modular spacing	19 inch
Number of rack units (RU)	6
Max. load capacity	63 kg

Environ WR500 Wall Rack 6U x 600 mm Wide x 500 mm Deep - Black

Item Code: WB6.5SGB



Material	Steel
Type of surface	Powder coated
Colour	Black
RAL-number	9004
IP-rating	IP20

Additional specifications

Features	Values
Frame	1.20mm
Top cover and fan entry plate	1.20mm
19" mounting angles	1.50mm
Side panels	1.20mm
Front door frame	1.20mm
Front door glass	5.00mm
Cable Entry Knock Out (Roof & Base)	230 mm x 45 mm

Standards

Standard	Detail
BS EN 60297-3-100:2009	Mechanical structures for electronic equipment. Dimensions of mechanical structures of the 482,6 mm (19 in) series. Basic dimensions of front panels, subracks, chassis, racks and cabinets
BS 3193:2008	Specification for thermally toughened glass panels for use in domestic appliances

Environ WR500 Wall Rack 6U x 600 mm Wide x 500 mm Deep - Black

Item Code: WB6.5SGB

excel
without compromise.

Product images



- Aesthetically pleasing design with framed glass front door



- Lockable, quick release side panels, for maximum access into cabinet



- Cable entry cut out in top and base

- Angled vented roof

- Adjustable 19" mounting profiles

Environ WR500 Wall Rack 6U x 600 mm Wide x 500 mm Deep - Black

Item Code: WB6.5SGB



Exploded view

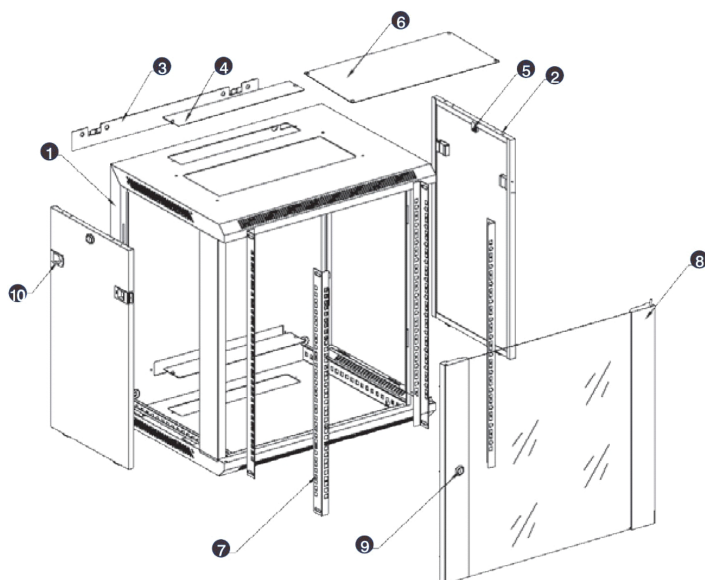

- ① Frame
- ② Side panel
- ③ Mounting panel
- ④ Cable entry cover, removeable
- ⑤ Side key lock
- ⑥ Fan cover, removeable
- ⑦ Mounting profile
- ⑧ Front door
- ⑨ Front door key lock
- ⑩ Slam latch lock



- ① Slam latch lock
- ② Side panel
- ③ Mounting panel
- ④ Cable entry cover, removeable
- ⑤ Side key lock
- ⑥ Fan cover, removeable
- ⑦ Mounting profile
- ⑧ Front door
- ⑨ Front door key lock

Environ WR500 Wall Rack 6U x 600 mm Wide x 500 mm Deep - Black

Item Code: WB6.5SGB



Product drawings

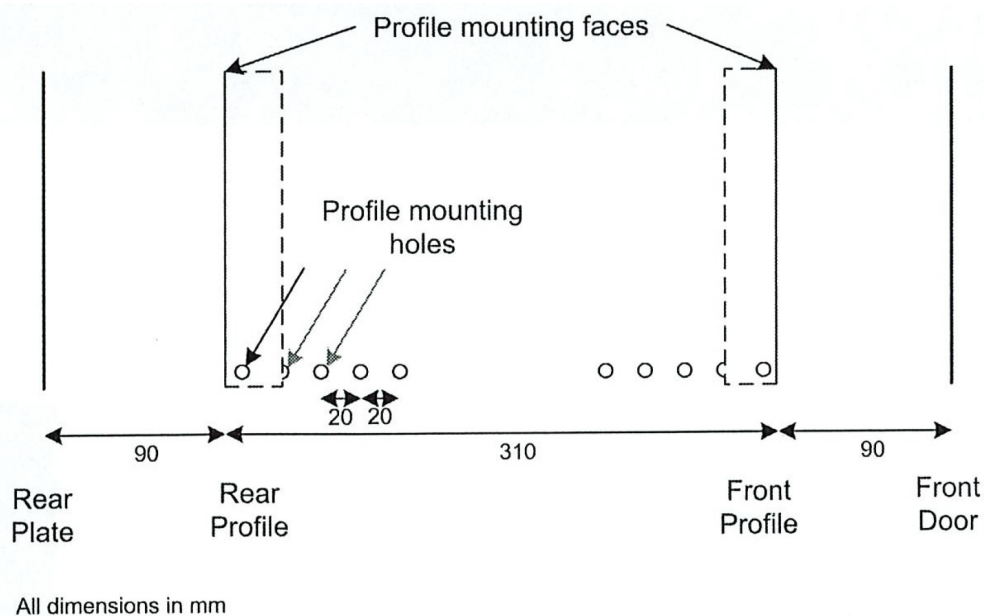

Part Number Table

Part Number	Description
WB12.5SG	Environ WR500 Wall Rack 12U x 600 mm Wide x 500 mm Deep - Grey
WB12.5SGB	Environ WR500 Wall Rack 12U x 600 mm Wide x 500 mm Deep - Black
WB15.5SG	Environ WR500 Wall Rack 15U x 600 mm Wide x 500 mm Deep - Grey
WB15.5SGB	Environ WR500 Wall Rack 15U x 600 mm Wide x 500 mm Deep - Black
WB18.5SG	Environ WR500 Wall Rack 18U x 600 mm Wide x 500 mm Deep - Grey
WB18.5SGB	Environ WR500 Wall Rack 18U x 600 mm Wide x 500 mm Deep - Black
WB21.5SG	Environ WR500 Wall Rack 21U x 600 mm Wide x 500 mm Deep - Grey
WB21.5SGB	Environ WR500 Wall Rack 21U x 600 mm Wide x 500 mm Deep - Black
WB6.5SG	Environ WR500 Wall Rack 6U x 600 mm Wide x 500 mm Deep - Grey
WB6.5SGB	Environ WR500 Wall Rack 6U x 600 mm Wide x 500 mm Deep - Black
WB9.5SG	Environ WR500 Wall Rack 9U x 600 mm Wide x 500 mm Deep - Grey
WB9.5SGB	Environ WR500 Wall Rack 9U x 600 mm Wide x 500 mm Deep - Black
WBFP12.5SG	Environ WR500 Wall Rack 12U x 600 mm Wide x 500 mm Deep - Grey, Flat Pack

Environ WR500 Wall Rack 6U x 600 mm Wide x 500 mm Deep - Black

Item Code: WB6.5SGB



WBFP12.5SGB	Environ WR500 Wall Rack 12U x 600 mm Wide x 500 mm Deep - Black, Flat Pack
WBFP15.5SG	Environ WR500 Wall Rack 15U x 600 mm Wide x 500 mm Deep - Grey, Flat Pack
WBFP15.5SGB	Environ WR500 Wall Rack 15U x 600 mm Wide x 500 mm Deep - Black, Flat Pack
WBFP18.5SG	Environ WR500 Wall Rack 18U x 600 mm Wide x 500 mm Deep - Grey, Flat Pack
WBFP18.5SGB	Environ WR500 Wall Rack 18U x 600 mm Wide x 500 mm Deep - Black, Flat Pack
WBFP21.5SG	Environ WR500 Wall Rack 21U x 600 mm Wide x 500 mm Deep - Grey, Flat Pack
WBFP21.5SGB	Environ WR500 Wall Rack 21U x 600 mm Wide x 500 mm Deep - Black, Flat Pack
WBFP6.5SG	Environ WR500 Wall Rack 6U x 600 mm Wide x 500 mm Deep - Grey, Flat Pack
WBFP6.5SGB	Environ WR500 Wall Rack 6U x 600 mm Wide x 500 mm Deep - Black, Flat Pack
WBFP9.5SG	Environ WR500 Wall Rack 9U x 600 mm Wide x 500 mm Deep - Grey, Flat Pack
WBFP9.5SGB	Environ WR500 Wall Rack 9U x 600 mm Wide x 500 mm Deep - Black, Flat Pack

Excel is a world class premium performing end to end infrastructure solution designed, Manufactured, supported and delivered without compromise.

Contact us at sales@excel-networking.com



E&OE. Excel is a registered trade name of Mayflex Holdings Ltd.